

1.3: Vector Equations

Math 220: Linear Algebra

Vectors in \mathbb{R}^2

A matrix with one column is called a column vector or vector

$$\mathbf{u} = \begin{bmatrix} 2 \\ 3 \end{bmatrix} \quad \mathbf{v} = \begin{bmatrix} v_1 \\ v_2 \end{bmatrix} \quad \mathbf{w} = \begin{bmatrix} w_1 \\ w_2 \\ \vdots \\ w_n \end{bmatrix}$$

Vectors are equal if and only if the corresponding entries are equal.

The sum of the vectors \mathbf{u} and \mathbf{v} is the vector $\vec{u} + \vec{v} = \begin{bmatrix} 2 \\ 3 \end{bmatrix} + \begin{bmatrix} v_1 \\ v_2 \end{bmatrix} = \begin{bmatrix} 2 + v_1 \\ 3 + v_2 \end{bmatrix}$

The scalar multiple of vector \mathbf{w} by a real number c is the vector $c\mathbf{w}$ where each component of \mathbf{w} is multiplied by c . $c\vec{w} = c \begin{bmatrix} w_1 \\ \vdots \\ w_n \end{bmatrix} = \begin{bmatrix} cw_1 \\ \vdots \\ cw_n \end{bmatrix}$

Ex 1: Given $\mathbf{u} = \begin{bmatrix} 3 \\ -2 \end{bmatrix}$ and $\mathbf{v} = \begin{bmatrix} -1 \\ 4 \end{bmatrix}$ find

a) $\mathbf{u} + \mathbf{v} = \begin{bmatrix} 3 \\ -2 \end{bmatrix} + \begin{bmatrix} -1 \\ 4 \end{bmatrix} = \begin{bmatrix} 2 \\ 2 \end{bmatrix}$

b) $3\mathbf{u} = 3 \begin{bmatrix} 3 \\ -2 \end{bmatrix} = \begin{bmatrix} 9 \\ -6 \end{bmatrix}$

c) $2\mathbf{u} - 5\mathbf{v} = 2 \begin{bmatrix} 3 \\ -2 \end{bmatrix} - 5 \begin{bmatrix} -1 \\ 4 \end{bmatrix} = \begin{bmatrix} 11 \\ -24 \end{bmatrix}$

Geometric Descriptions of \mathbb{R}^2

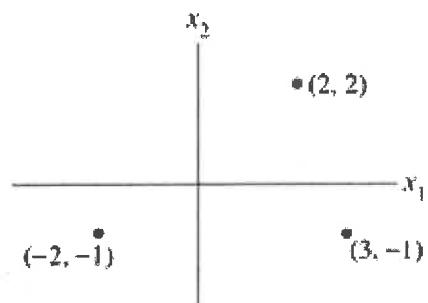

vectors have a direction and magnitude.

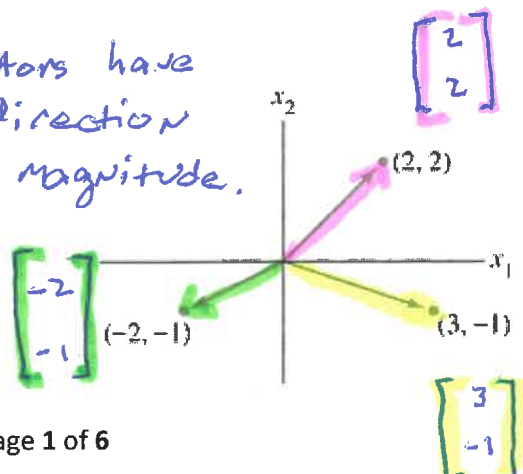

1.3: Vector Equations

Parallelogram Rule for Addition

If \mathbf{u} and \mathbf{v} in \mathbb{R}^2 are represented as points in the plane, then $\mathbf{u} + \mathbf{v}$ corresponds to the fourth vertex of the parallelogram whose other vertices are \mathbf{u} , $\mathbf{0}$, and \mathbf{v} . See Figure 3.

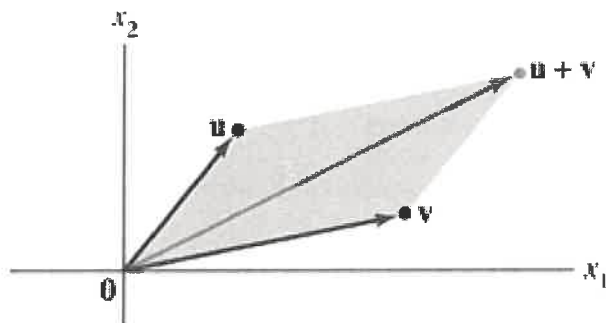

Ex 2: Given $\mathbf{u} = \begin{bmatrix} 1 \\ -2 \end{bmatrix}$ and $\mathbf{v} = \begin{bmatrix} 4 \\ 2 \end{bmatrix}$, draw their vectors and the following.

a) $\mathbf{u} + \mathbf{v} = \begin{bmatrix} 5 \\ 0 \end{bmatrix}$

b) $3\mathbf{u} = \begin{bmatrix} 3 \\ -6 \end{bmatrix}$

c) $-\frac{1}{2}\mathbf{v} = \begin{bmatrix} -2 \\ -1 \end{bmatrix}$

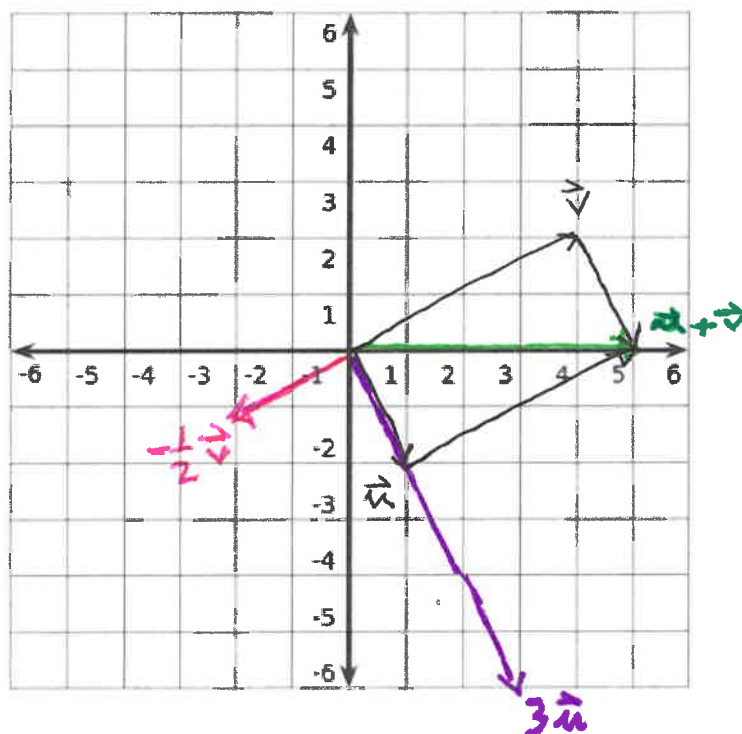

Vectors in \mathbb{R}^3

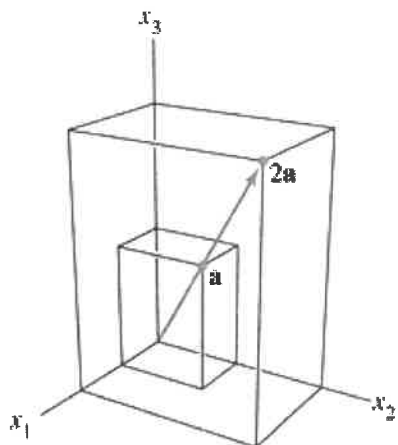

Vectors in \mathbb{R}^n

$$\mathbf{u} = \begin{bmatrix} u_1 \\ u_2 \\ \vdots \\ u_n \end{bmatrix}$$

The Zero vector has entries of all zero, denoted by $\mathbf{0}$ or

$$\mathbf{0} = \begin{bmatrix} 0 \\ 0 \\ \vdots \\ 0 \end{bmatrix}$$

1.3: Vector Equations

Algebraic Properties of \mathbb{R}^n

For all $\mathbf{u}, \mathbf{v}, \mathbf{w}$ in \mathbb{R}^n and all scalars c and d :

(i) $\mathbf{u} + \mathbf{v} = \mathbf{v} + \mathbf{u}$

(ii) $(\mathbf{u} + \mathbf{v}) + \mathbf{w} = \mathbf{u} + (\mathbf{v} + \mathbf{w})$

(iii) $\mathbf{u} + \mathbf{0} = \mathbf{0} + \mathbf{u} = \mathbf{u}$

(iv) $\mathbf{u} + (-\mathbf{u}) = -\mathbf{u} + \mathbf{u} = \mathbf{0}$, where $-\mathbf{u}$ denotes $(-1)\mathbf{u}$

(v) $c(\mathbf{u} + \mathbf{v}) = c\mathbf{u} + c\mathbf{v}$

(vi) $(c + d)\mathbf{u} = c\mathbf{u} + d\mathbf{u}$

(vii) $c(d\mathbf{u}) = (cd)\mathbf{u}$

(viii) $1\mathbf{u} = \mathbf{u}$

Prove (i) and (v)

(i) claim: $\vec{u} + \vec{v} = \vec{v} + \vec{u}$

proof.

Let $\vec{u}, \vec{v} \in \mathbb{R}^n$ be given.

\Rightarrow there exist u_1, \dots, u_n and v_1, \dots, v_n s.t.

$$\vec{u} + \vec{v} = \begin{bmatrix} u_1 \\ \vdots \\ u_n \end{bmatrix} + \begin{bmatrix} v_1 \\ \vdots \\ v_n \end{bmatrix}$$

$$= \begin{bmatrix} u_1 + v_1 \\ \vdots \\ u_n + v_n \end{bmatrix}$$

$$= \begin{bmatrix} v_1 + u_1 \\ \vdots \\ v_n + u_n \end{bmatrix}$$

$$= \begin{bmatrix} v_1 \\ \vdots \\ v_n \end{bmatrix} + \begin{bmatrix} u_1 \\ \vdots \\ u_n \end{bmatrix}$$

commutative property of real numbers

$\Rightarrow = \vec{v} + \vec{u}$
 $\therefore \vec{u} + \vec{v} = \vec{v} + \vec{u}$

(v) claim: $c(\vec{u} + \vec{v}) = c\vec{u} + c\vec{v}$
 proof.

Let $\mathbf{u}, \mathbf{v} \in \mathbb{R}^n$ and scalar c be given.

\Rightarrow there exists u_1, \dots, u_n and v_1, \dots, v_n s.t.

$$c(\vec{u} + \vec{v}) = c \left(\begin{bmatrix} u_1 \\ \vdots \\ u_n \end{bmatrix} + \begin{bmatrix} v_1 \\ \vdots \\ v_n \end{bmatrix} \right)$$

$$= c \begin{bmatrix} u_1 + v_1 \\ \vdots \\ u_n + v_n \end{bmatrix}$$

$$= \begin{bmatrix} c(u_1 + v_1) \\ \vdots \\ c(u_n + v_n) \end{bmatrix}$$

$$= \begin{bmatrix} cu_1 + cv_1 \\ \vdots \\ cu_n + cv_n \end{bmatrix}$$

$$= \begin{bmatrix} cu_1 \\ \vdots \\ cu_n \end{bmatrix} + \begin{bmatrix} cv_1 \\ \vdots \\ cv_n \end{bmatrix} \quad \square$$

distributive property of addition of real numbers

$$\hookrightarrow = c \begin{bmatrix} u_1 \\ \vdots \\ u_n \end{bmatrix} + c \begin{bmatrix} v_1 \\ \vdots \\ v_n \end{bmatrix}$$

$$= c \vec{u} + c \vec{v}$$

$$\therefore c(\vec{u} + \vec{v}) = c\vec{u} + c\vec{v},$$

1.3: Vector Equations

Linear Combinations

Given vectors $\mathbf{v}_1, \mathbf{v}_2, \dots, \mathbf{v}_p$ in \mathbb{R}^n and given scalars c_1, c_2, \dots, c_p , the vector \mathbf{y} defined by

$$\mathbf{y} = c_1 \mathbf{v}_1 + \dots + c_p \mathbf{v}_p$$

is called a **linear combination** of $\mathbf{v}_1, \dots, \mathbf{v}_p$ with **weights** c_1, \dots, c_p .

Ex 3: The figure identifies selected linear combinations of $\mathbf{v}_1 = \begin{bmatrix} -1 \\ 1 \end{bmatrix}$ and $\mathbf{v}_2 = \begin{bmatrix} 2 \\ 1 \end{bmatrix}$

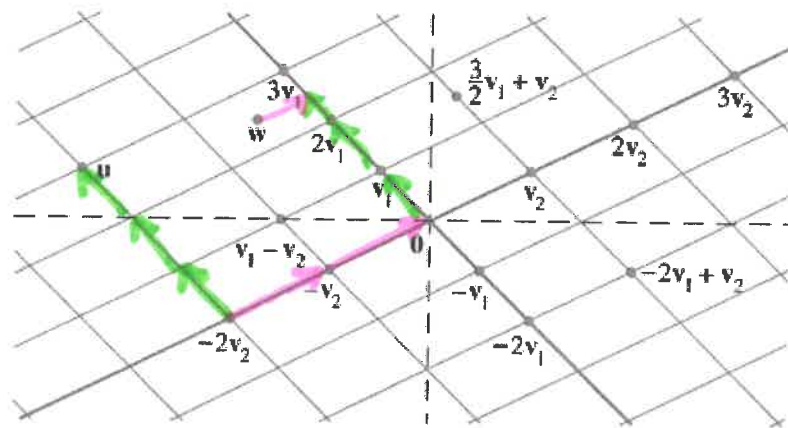

$$\mathbf{u} = 3\mathbf{v}_1 + (-2)\mathbf{v}_2$$

$$\mathbf{w} = \frac{5}{2}\mathbf{v}_1 + \left(-\frac{1}{2}\right)\mathbf{v}_2$$

Ex 4: Determine whether \mathbf{b} can be written as a linear combination of $\mathbf{a}_1, \mathbf{a}_2, \mathbf{a}_3$.

$$\mathbf{a}_1 = \begin{bmatrix} 1 \\ -2 \\ 0 \end{bmatrix}, \mathbf{a}_2 = \begin{bmatrix} 0 \\ 1 \\ 2 \end{bmatrix}, \mathbf{a}_3 = \begin{bmatrix} 5 \\ -6 \\ 8 \end{bmatrix}, \mathbf{b} = \begin{bmatrix} 2 \\ -1 \\ 6 \end{bmatrix}$$

solve $c_1 \begin{bmatrix} 1 \\ -2 \\ 0 \end{bmatrix} + c_2 \begin{bmatrix} 0 \\ 1 \\ 2 \end{bmatrix} + c_3 \begin{bmatrix} 5 \\ -6 \\ 8 \end{bmatrix} = \begin{bmatrix} 2 \\ -1 \\ 6 \end{bmatrix}$

$$\Rightarrow \begin{bmatrix} c_1 + 5c_3 \\ -2c_1 + c_2 - 6c_3 \\ +2c_2 + 8c_3 \end{bmatrix} = \begin{bmatrix} 2 \\ -1 \\ 6 \end{bmatrix}$$

write as an augmented matrix

$$\begin{bmatrix} 1 & 0 & 5 & 2 \\ -2 & 1 & -6 & -1 \\ 0 & 2 & 8 & 6 \end{bmatrix}$$

$$\begin{aligned} c_1 + 5c_3 &= 2 \\ \Rightarrow -2c_1 + c_2 - 6c_3 &= -1 \\ 2c_2 + 8c_3 &= 6 \end{aligned}$$

REF
ON the
calculator

$$\sim \begin{bmatrix} 1 & 0 & 5 & 2 \\ 0 & 1 & 4 & 3 \\ 0 & 0 & 0 & 0 \end{bmatrix}$$

$$\begin{cases} c_1 + 5c_3 = 2 \\ c_2 + 4c_3 = 3 \end{cases}$$

$$c_2 + 4c_3 = 3$$

$$c_1 = 2 - 5c_3$$

$$\Rightarrow c_2 = 3 - 4c_3$$

$$c_3 = c_3 \text{ (free)}$$

$$\text{OR } \begin{bmatrix} c_1 \\ c_2 \\ c_3 \end{bmatrix} = \begin{bmatrix} 2 \\ 3 \\ 0 \end{bmatrix} + c_3 \begin{bmatrix} -5 \\ -4 \\ 1 \end{bmatrix}$$

$\therefore \vec{b}$ can be written as a linear combination of $\vec{a}_1, \vec{a}_2, \vec{a}_3$. There are an infinite ways

One example when $c_3 = 2$ (my choice)

$$\text{is } -8\vec{a}_1 + -5\vec{a}_2 + 2\vec{a}_3 = \vec{b}$$

1.3: Vector Equations

A vector equation

$$x_1 \mathbf{a}_1 + x_2 \mathbf{a}_2 + \dots + x_n \mathbf{a}_n = \mathbf{b}$$

has the same solution set as the linear system whose augmented matrix is

$$[\mathbf{a}_1 \ \mathbf{a}_2 \ \dots \ \mathbf{a}_n \ \mathbf{b}] \quad (5)$$

In particular, \mathbf{b} can be generated by a linear combination of $\mathbf{a}_1, \dots, \mathbf{a}_n$ if and only if there exists a solution to the linear system corresponding to the matrix (5).

Definition

If $\mathbf{v}_1, \dots, \mathbf{v}_p$ are in \mathbb{R}^n , then the set of all linear combinations of $\mathbf{v}_1, \dots, \mathbf{v}_p$ is denoted by $\text{Span}\{\mathbf{v}_1, \dots, \mathbf{v}_p\}$ and is called the **subset of \mathbb{R}^n spanned (or generated) by $\mathbf{v}_1, \dots, \mathbf{v}_p$** . That is, $\text{Span}\{\mathbf{v}_1, \dots, \mathbf{v}_p\}$ is the collection of all vectors that can be written in the form

$$c_1 \mathbf{v}_1 + c_2 \mathbf{v}_2 + \dots + c_p \mathbf{v}_p$$

with c_1, \dots, c_p scalars.

*this means there exist c_1, \dots, c_p
s.t. $c_1 \vec{v}_1 + \dots + c_p \vec{v}_p = \vec{b}$*

$\mathbf{b} \in \text{Span}\{\mathbf{v}_1, \mathbf{v}_2, \dots, \mathbf{v}_p\}$?

*translates \vec{b} is contained in the span
or \vec{b} is an element of the span*

Every scalar multiple of individual vectors, $c \mathbf{v}_k \in \text{span}$ because

$$c \vec{v}_k = 0 \vec{v}_1 + 0 \vec{v}_2 + \dots + 0 \vec{v}_{k-1} + c \vec{v}_k + 0 \vec{v}_{k+1} + \dots + 0 \vec{v}_p$$

for $k = 1, 2, \dots, p$.

Geometric Description of $\text{Span}\{\mathbf{v}\}$ and $\text{Span}\{\mathbf{u}, \mathbf{v}\}$

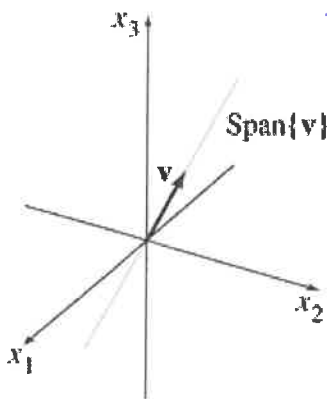

*the span of
one non-zero
vector is
a "line."*

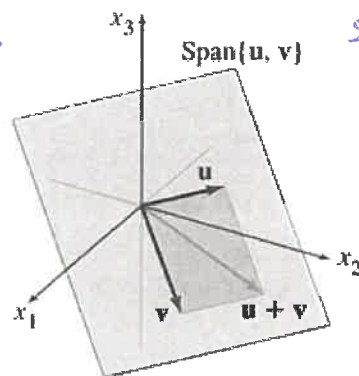

*provided \vec{u}, \vec{v} are
not parallel, their
span is a "plane."*

1.3: Vector Equations

Ex 5: Let $\mathbf{a}_1 = \begin{bmatrix} 1 \\ 3 \\ -2 \end{bmatrix}$, $\mathbf{a}_2 = \begin{bmatrix} 3 \\ 10 \\ -4 \end{bmatrix}$, and $\mathbf{b} = \begin{bmatrix} -1 \\ 4 \\ 2 \end{bmatrix}$. $\text{Span}\{\mathbf{a}_1, \mathbf{a}_2\}$ is a plane in \mathbb{R}^3 .

Is \mathbf{b} in that plane?

$$\text{rref} \left(\begin{bmatrix} 1 & 3 & -1 \\ 3 & 10 & 4 \\ -2 & -4 & 2 \end{bmatrix} \right) = \begin{bmatrix} 1 & 0 & 0 \\ 0 & 1 & 0 \\ 0 & 0 & 1 \end{bmatrix} \leftarrow \begin{array}{l} \text{inconsistent} \\ \text{system.} \end{array}$$

$\therefore \text{No, } \vec{b} \notin \text{span}\{\vec{a}_1, \vec{a}_2\}$

Ex 6: Let $\mathbf{v}_1 = \begin{bmatrix} 1 \\ 0 \\ -2 \end{bmatrix}$, $\mathbf{v}_2 = \begin{bmatrix} -3 \\ 1 \\ 8 \end{bmatrix}$, and $\mathbf{y} = \begin{bmatrix} h \\ -5 \\ -3 \end{bmatrix}$

For what value(s) of h is \mathbf{y} in the plane generated by \mathbf{v}_1 and \mathbf{v}_2 ?

$$\begin{bmatrix} 1 & -3 & h \\ 0 & 1 & -5 \\ -2 & 8 & -3 \end{bmatrix} \quad R_3 + 2R_1 \rightarrow R_3$$

$$\begin{bmatrix} 1 & -3 & h \\ 0 & 1 & -5 \\ 0 & 2 & -3+2h \end{bmatrix} \quad R_3 - 2R_2 \rightarrow R_3$$

$$\begin{bmatrix} 1 & -3 & h \\ 0 & 1 & -5 \\ 0 & 0 & 7+2h \end{bmatrix}$$

in order to be consistent $7+2h=0$
 $\Rightarrow h = -7/2$

so \vec{y} is in the plane iff $h = -7/2$