

We have studied integrals on intervals on the real line, on regions in the plane, on solid regions in space, and along curves in space. One situation is still unexplored. Suppose a sphere has a known temperature distribution; perhaps it is cold near the poles and warm near the equator. How do you find the average temperature over the entire sphere? In analogy with other average value calculations, we should expect to "add up" the temperature values over the sphere and divide by the surface area of the sphere. Because the temperature varies continuously over the sphere, adding up means integrating. How do you integrate a function over a surface? This question leads to surface integrals.

It helps to keep curves, arc length, and line integrals in mind as we discuss surfaces, surface area, and surface integrals. What we discover about surfaces parallels what we already know about curves - all "lifted" up one dimension.

### Parallel Concepts

#### Curves

- Arc length
- Line integrals
- Parameterization with one parameter  $t$

#### Surfaces

- Surface area
- Surface integrals
- Parameterization with two parameters  $u$  and  $v$

Objective:

1. Parametric surfaces
2. Surface integrals
3. Surface integrals of vector fields

### 1. Parametric surfaces

A curve in  $\mathbb{R}^2$  is defined parametrically by  $\vec{r}(t) = \langle x(t), y(t), z(t) \rangle$ , for  $a \leq t \leq b$ ; it requires one parameter and two dependent variables. Stepping up one dimension, to define a surface in  $\mathbb{R}^3$  we need two parameters and three dependent variables. Letting  $u$  and  $v$  be parameters, the general parametric description of a surface has the form:  $\vec{r}(u, v) = \langle x(u, v), y(u, v), z(u, v) \rangle$ .

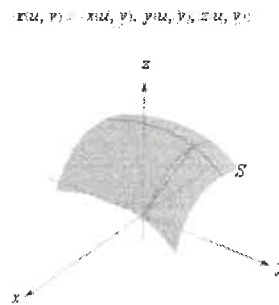
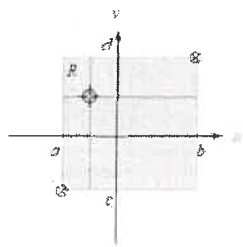

A rectangle in  $zv$ -plane is mapped to a surface in  $xyz$ -space.



check out  
manipulate  
17.43

We make the assumption that the parameters vary over a rectangle  $R = \{(u, v) : a \leq u \leq b, c \leq v \leq d\}$ .

As the parameters  $(u, v)$  vary over  $R$ , the vector  $\vec{r}(u, v) = \langle x(u, v), y(u, v), z(u, v) \rangle$  sweeps out a surface  $S$  in  $\mathbb{R}^3$ . Here are three graphical examples:

- A cylinder:

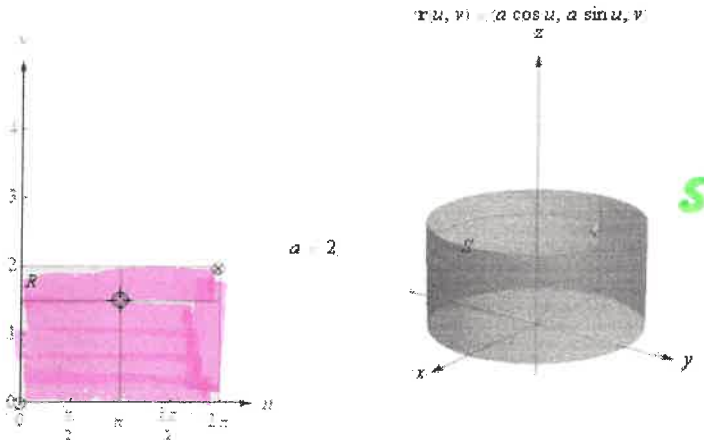

check out  
manipulate  
17.44

- A cone:

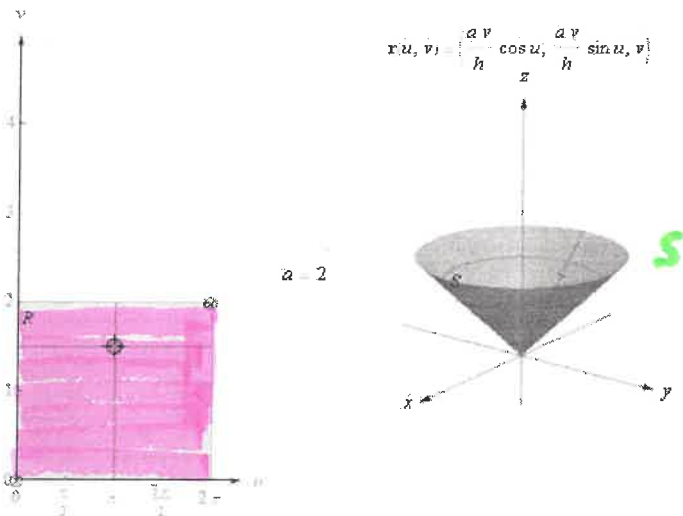

check out  
manipulate  
17.45



• A sphere?

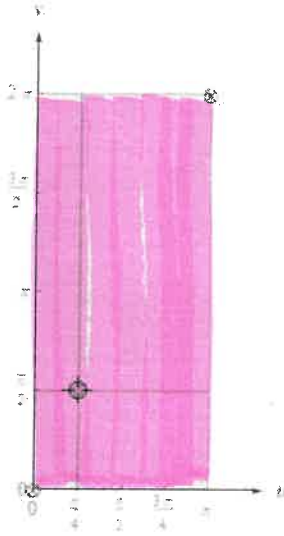

$$\vec{r}(u, v) = \langle a \sin u \cos v, a \sin u \sin v, a \cos u \rangle$$

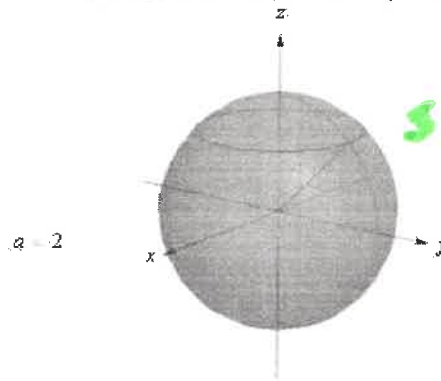

check out  
manipulate  
17.46

• A function:

One other key example is when a surface is described explicitly as  $z = g(x, y)$ . In this case we parameterize with  $\vec{r}(u, v) = \langle u, v, g(u, v) \rangle$  or even better  $\vec{r}(x, y) = \langle x, y, g(x, y) \rangle$ .

## 2. Surface Integrals

We now develop the surface integral of a scalar-valued function  $f$  on a smooth parameterized surface  $S$  described by the equation  $\vec{r}(u, v) = \langle x(u, v), y(u, v), z(u, v) \rangle$  where the parameters vary over a rectangle  $R = \{(u, v) : a \leq u \leq b, c \leq v \leq d\}$ . The functions  $x$ ,  $y$ , and  $z$  are assumed to have continuous partial derivatives with respect to  $u$  and  $v$ .

The rectangular region  $R$  in the  $uv$ -plane is partitioned into rectangles, with sides of length  $\Delta u$  and  $\Delta v$ , that are ordered in some convenient way, for  $k=1, \dots, n$ . The  $k$ th rectangle  $R_k$  corresponds to a curved patch  $S_k$  on the surface  $S$ , which has area  $\Delta S_k$ .

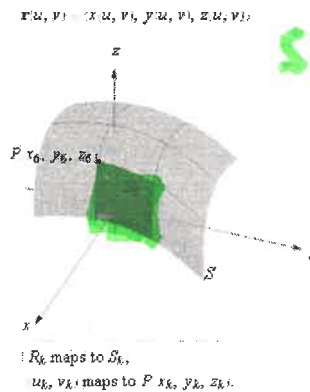
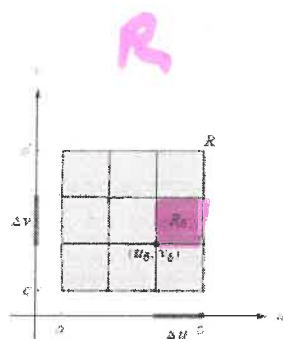

check out  
manipulate  
17.47

To construct the surface integral we define a Riemann sum, which adds up function values multiplied by areas of the respective patches:  $\sum_{k=1}^n f(x_k, y_k, z_k) \Delta S_k$ . But what is  $\Delta S_k$ ? Consider the pic

$$\vec{r}(u, v) = (x(u, v), y(u, v), z(u, v))$$

$$|\vec{t}_u \Delta u \times \vec{t}_v \Delta v| = |\vec{t}_u \times \vec{t}_v| \Delta u \Delta v = \Delta S_k$$

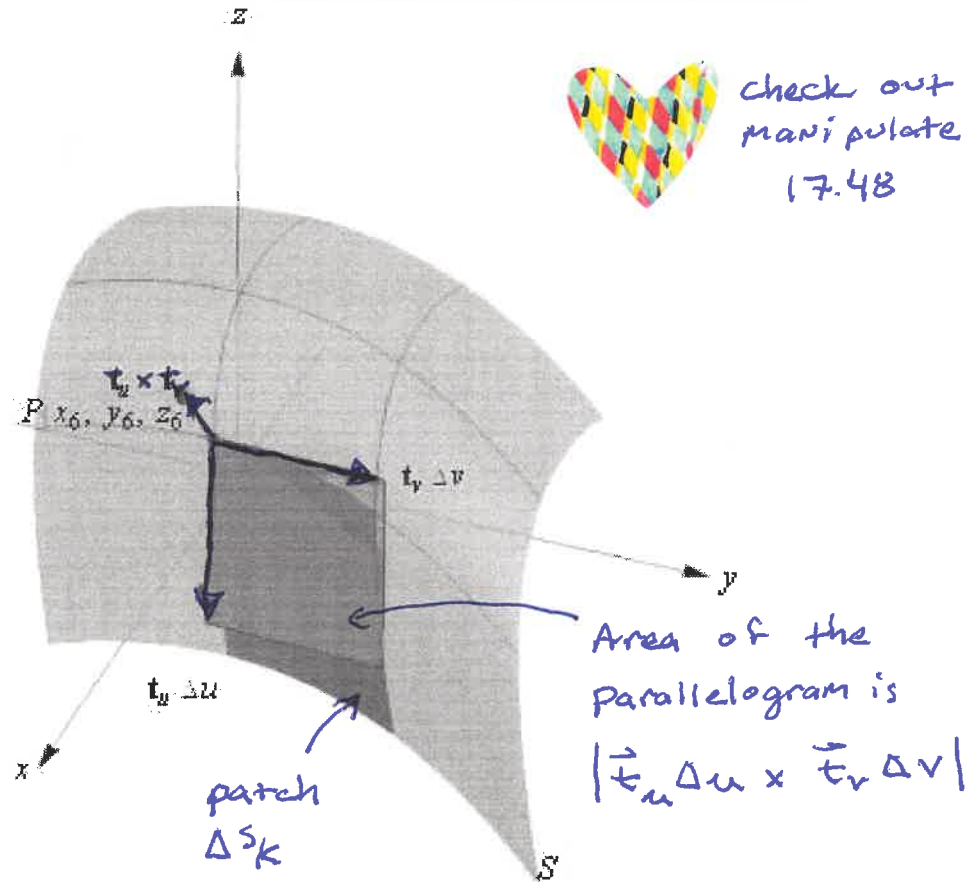

Parallelogram in tangent plane has area  $|\vec{t}_u \Delta u \times \vec{t}_v \Delta v|$

Two special vectors are tangent to the surface at P; these vectors lie in the plane tangent to S at P.

- $\vec{t}_u = \frac{\partial \vec{r}}{\partial u}$  is a vector tangent to the surface corresponding to a change in  $u$  with  $v$  held constant.
- $\vec{t}_v = \frac{\partial \vec{r}}{\partial v}$  is a vector tangent to the surface corresponding to a change in  $v$  with  $u$  held constant.

The details require care and are mapped out in the text. But the main point is that the area of the patch is approximated by the area of the parallelogram which has area  $\Delta S_k = |\vec{t}_u \Delta u \times \vec{t}_v \Delta v| = |\vec{t}_u \times \vec{t}_v| \Delta u \Delta v$

Thus  $\sum_{k=1}^n f(x_k, y_k, z_k) \Delta S_k = \sum_{k=1}^n f(x_k, y_k, z_k) |\vec{t}_u \times \vec{t}_v| \Delta u \Delta v$  and allowing the widths of rectangles in terms of  $u$  and  $v$  approach zero, we arrive at:

$$\iint_S f(x, y, z) dS = \lim_{\Delta u, \Delta v \rightarrow 0} \sum_{k=1}^n f(x_k, y_k, z_k) |\vec{t}_u \times \vec{t}_v| \Delta u \Delta v$$

**Definition:** Surface Integral of Scalar-Valued Functions on Parameterized Surfaces

Let  $f$  be a continuous scalar-valued function on a smooth surface  $S$  given parametrically by  $\vec{r}(u, v) = \langle x(u, v), y(u, v), z(u, v) \rangle$ , where  $u$  and  $v$  where the parameters vary over a rectangle  $R = \{(u, v) : a \leq u \leq b, c \leq v \leq d\}$ . Assume also that the tangent vectors

$$\vec{t}_u = \frac{\partial \vec{r}}{\partial u} = \left\langle \frac{\partial x}{\partial u}, \frac{\partial y}{\partial u}, \frac{\partial z}{\partial u} \right\rangle \text{ and } \vec{t}_v = \frac{\partial \vec{r}}{\partial v} = \left\langle \frac{\partial x}{\partial v}, \frac{\partial y}{\partial v}, \frac{\partial z}{\partial v} \right\rangle \text{ are continuous on } R \text{ and the normal}$$

vector  $\vec{t}_u \times \vec{t}_v$  is nonzero on  $R$ . Then the surface integral of  $f$  over  $S$  is

$$\iint_R f(x, y, z) dS = \iint_R f(x(u, v), y(u, v), z(u, v)) |\vec{t}_u \times \vec{t}_v| dA$$

Important note: If  $f(x, y, z) = 1$ , then the surface integral represents the area of  $S$ .

Ex1: Evaluate the surface integral  $\iint_S xyz dS$  where  $S$  is the <sup>part of a</sup> cone with parametric equations

$$x = u \cos v \quad y = u \sin v \quad z = u \quad 0 \leq u \leq 1 \quad 0 \leq v \leq \pi/2$$

step 1: parameterize

$$\vec{r}(u, v) = \langle u \cos v, u \sin v, u \rangle \text{ on}$$

$$0 \leq u \leq 1 \\ 0 \leq v \leq \pi/2$$

step 2:  $dS$

$$\vec{t}_u = \langle \cos v, \sin v, 1 \rangle \dots \left( \frac{\partial \vec{r}}{\partial u} \right)$$

$$\vec{t}_v = \langle -u \sin v, u \cos v, 0 \rangle \dots \left( \frac{\partial \vec{r}}{\partial v} \right)$$

$$\vec{t}_u \times \vec{t}_v = \langle -u \cos v, u \sin v, u \rangle$$

$$|\vec{t}_u \times \vec{t}_v| = \sqrt{u^2 \sin^2 v + u^2 \cos^2 v + u^2} = \sqrt{2u^2}$$

step 3: substitute and integrate

$$\iint_S xyz \, dS = \int_0^1 \int_0^{\pi/2} u \cos v \cdot u \sin v \cdot u \cdot \sqrt{2} u^2 \, dv \, du$$

$$= \sqrt{2} \int_0^1 u^4 \, du \int_0^{\pi/2} \cos v \sin v \, dv$$

$$= \frac{\sqrt{2}}{5} \cdot \frac{1}{2} \left[ \sin^2 v \right]_0^{\pi/2}$$

$$= \frac{\sqrt{2}}{10}$$

Notation:  $ds$  vs  $dS$

- For line integrals we have  $ds = |\vec{r}'(t)| dt$ .
- For surface integrals we have  $dS = |\vec{i}_u \times \vec{i}_v| dA$  or perhaps  $dS = \left| \frac{\partial \vec{r}}{\partial u} \times \frac{\partial \vec{r}}{\partial v} \right| du dv$

Ex2: Evaluate the surface integral  $\iint_S xz dS$  where  $S$  is the part of the plane  $x+y+z=1$  that lies in the first octant.

step 1: parameterize  $z = 1 - x - y$

$$\vec{r}(x,y) = \langle x, y, 1-x-y \rangle$$

step 2:

$$z_x = \langle 1, 0, -1 \rangle$$

$$z_y = \langle 0, 1, -1 \rangle$$

$$z_x \times z_y = \langle 1, 1, 1 \rangle$$

$$|z_x \times z_y| = \sqrt{3}$$

step 3: substitute and integrate

$$\begin{aligned} \iint_S xz dS &= \int_0^1 \int_0^{1-x} x(1-x-y) \sqrt{3} dy dx \\ &= \sqrt{3} \int_0^1 \left[ xy - x^2y - \frac{1}{2}xy^2 \right]_{y=0}^{y=1-x} dx \\ &= \sqrt{3} \int_0^1 x(1-x) - x^2(1-x) - \frac{1}{2}x(1-x)^2 dx \\ &= \frac{\sqrt{3}}{2} \int_0^1 (x - 2x^2 + x^3) dx \end{aligned}$$

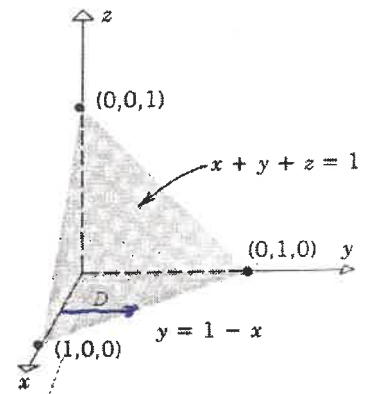

$$= \frac{\sqrt{3}}{2} \left( \frac{1}{2} - \frac{2}{3} + \frac{1}{4} \right) \quad \text{or} \quad \frac{\sqrt{3}}{24}$$

Theorem: Evaluation of Surface Integrals of Scalar-Valued Functions on Explicitly Defined Surfaces

Let  $f$  be a continuous function on a smooth surface  $S$  given by  $z = g(x, y)$ , for  $(x, y)$  in a region  $R$ . The surface integral of  $f$  over  $S$  is:

$$\iint_R f(x, y, z) dS = \iint_R f(x, y, g(x, y)) \sqrt{z_x^2 + z_y^2 + 1} dA$$

*This would have allowed you to skip to step 3 of ex. 2*

Once again, if  $f(x, y, z) = 1$ , then the surface integral represents the area of  $S$ .

Ex3: Evaluate the surface integral  $\iint_S y^2 z^2 dS$  where  $S$  is the part of the cone  $z = \sqrt{x^2 + y^2}$  that lies between the planes  $z = 1$  and  $z = 2$ .

$$\iint_S y^2 z^2 dS = \iint_{1 \leq x^2 + y^2 \leq 4} y^2 (x^2 + y^2) \sqrt{\frac{x^2 + y^2}{x^2 + y^2} + 1} dA$$

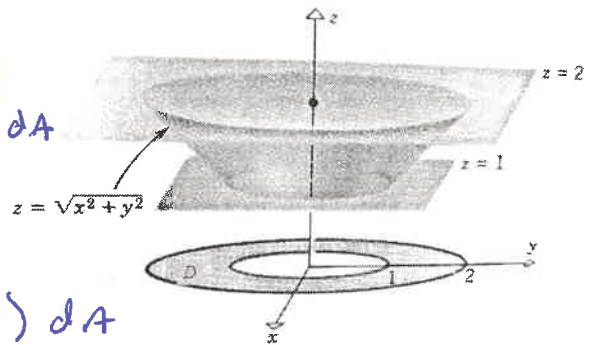

$$= \iint_{1 \leq x^2 + y^2 \leq 4} \sqrt{2} y^2 (x^2 + y^2) dA$$

$$= \int_0^{2\pi} \int_1^2 \sqrt{2} r^2 \sin^2 \theta (r^2) r dr d\theta$$

$$= \sqrt{2} \int_1^2 r^5 dr \int_0^{2\pi} \frac{1 - \cos 2\theta}{2} d\theta$$

$$= \frac{\sqrt{2}}{2} \left[ \frac{1}{6} r^6 \right]_1^2 \left[ \theta - \frac{1}{2} \sin 2\theta \right]_0^{2\pi}$$

$$= \frac{\sqrt{2} \pi}{6} (63)$$

$$= \frac{21\sqrt{2}\pi}{2}$$



### 3. Surface Integrals of Vector Fields

Just as we did with line integrals we now need to move on to surface integrals of vector fields. Recall that in line integrals the orientation of the curve we were integrating along could change the answer. The same thing will hold true with surface integrals. So, before we really get into doing surface integrals of vector fields we first need to introduce the idea of an **oriented (two sided) surface**.

An example of a nonoriented surface is a Mobius strip which has only one side.

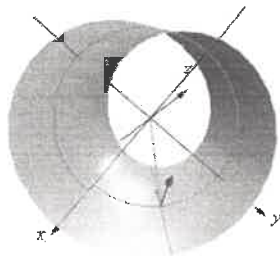
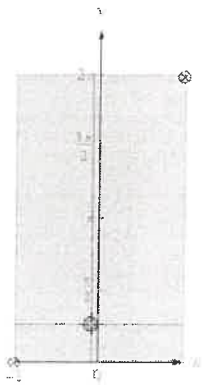

Not a Mobius strip

Let's start off with a surface that has two sides which means that it has a tangent plane at every point (except possibly along the boundary). Making this assumption means that every point will have two unit normal vectors,  $\vec{n}_1$  and  $\vec{n}_2 = -\vec{n}_1$ . This means that every surface will have two sets of normal vectors. If unit normal vector varies continuously over  $S$ , then  $S$  is called an **oriented surface**. The set that we choose will give the surface an **orientation**. Hence there are two possible orientations for any orientable surface.

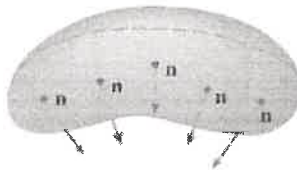
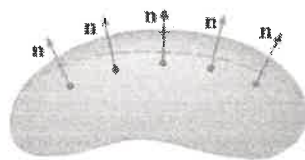
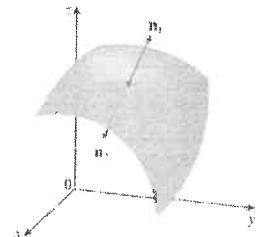

Suppose  $S$  is a smooth orientable surface given in parametric or vector form  $\vec{r}(u, v)$ . Since the normal vector is perpendicular to the tangent plane, and  $\vec{t}_u$  and  $\vec{t}_v$  are on the tangent plane, the normal vector

is their cross product. Unitizing it, we'll get the unit normal vector:  $\vec{n} = \frac{\vec{t}_u \times \vec{t}_v}{|\vec{t}_u \times \vec{t}_v|}$

Unless otherwise specified, we will assume that **upward** orientation (positive  $z$ ) is a positive orientation  $\vec{n}$  while **downward** orientation, is given by  $-\vec{n}$ . Similarly on closed surfaces, we assume that positive orientation points out of the closed surface.

Now we are ready to talk about the definition of surface integrals of vector fields over  $S$  which is equal to the surface integral of its normal component over  $S$ . This integral is used to calculate flux:

Definition: If  $\vec{F}$  is a continuous vector field defined on an oriented surface  $S$  with unit normal vector  $\vec{n}$ , then the flux as calculated using the surface integral of  $\vec{F}$  over  $S$  is:

$$\text{flux} = \iint_S \vec{F} \cdot d\vec{S} = \iint_S \vec{F} \cdot \vec{n} \, dS = \iint_R \vec{F} \cdot \frac{\vec{t}_u \times \vec{t}_v}{|\vec{t}_u \times \vec{t}_v|} |\vec{t}_u \times \vec{t}_v| \, dA = \iint_R \vec{F} \cdot (\vec{t}_u \times \vec{t}_v) \, dA$$

Ex4: Let  $S$  be the surface defined by  $x = u \cos v$   $y = u \sin v$   $z = u$   $0 \leq u \leq 1$   $0 \leq v \leq \pi/2$  and suppose that  $S$  is oriented upward. Find the flux of the flow field  $\vec{F}(x, y, z) = x\vec{i} + y\vec{j} + z\vec{k}$  across  $S$ .

recall from (ex1)  $\vec{E}_u \times \vec{E}_v = \langle -u \cos v, u \sin v, u \rangle$

$$\text{flux} = \int_0^{\pi/2} \int_0^1 \langle u \cos v, u \sin v, u \rangle \cdot \langle -u \cos v, u \sin v, u \rangle \, du \, dv$$

$$= \int_0^{\pi/2} \int_0^1 (-u^2 \cos^2 v + u^2 \sin^2 v + u^2) \, du \, dv$$

$$= \int_0^{\pi/2} \int_0^1 u^2 (1 - \cos 2v) \, du \, dv$$

$$= \int_0^1 u^2 \, du \int_0^{\pi/2} (1 - \cos 2v) \, dv$$

$$= \frac{1}{3} \left[ v - \frac{1}{2} \sin 2v \right]_0^{\pi/2}$$

$$= \frac{\pi}{6}$$

Now suppose  $z = g(x, y)$  is how we define the surface. Then:  $\vec{t}_x \times \vec{t}_y = \left\langle -\frac{\partial g}{\partial x}, -\frac{\partial g}{\partial y}, 1 \right\rangle$  and unitizing

it we'll have:  $\vec{F} \cdot (\vec{t}_x \times \vec{t}_y) = \langle f, g, h \rangle \cdot \left\langle -\frac{\partial g}{\partial x}, -\frac{\partial g}{\partial y}, 1 \right\rangle$  Hence:

$$\text{Flux} = \iint_S \vec{F} \cdot d\vec{S} = \iint_R \left( -f \frac{\partial g}{\partial x} - g \frac{\partial g}{\partial y} + h \right) dA$$

This formula assumes the upward orientation of  $S$ . For downward orientation, multiply by  $-1$ . Similar formulas can be worked out if  $S$  is given by  $y = h(x, z)$  or  $x = k(y, z)$ .

Ex5: Let  $S$  be the surface  $z = x \sin y$ ,  $0 \leq x \leq 2$ ,  $0 \leq y \leq \pi$  with upward orientation. Evaluate the surface integral  $\iint_S \vec{F} \cdot d\vec{S}$  of the vector field  $\vec{F}(x, y, z) = yz\vec{i} + zx\vec{j} + xy\vec{k}$ .

$$\begin{aligned} \text{Flux} &= \iint_S \vec{F} \cdot d\vec{S} \\ &= \int_0^2 \int_0^\pi (-yz \sin y - zx \cdot x \cos y + xy) dy dx \\ &= \int_0^2 \int_0^\pi (-y x \sin^2 y - x^3 \sin y \cos y + xy) dy dx \\ &= \frac{\pi^2}{2} \end{aligned}$$